

Day 1

Foundation of Love

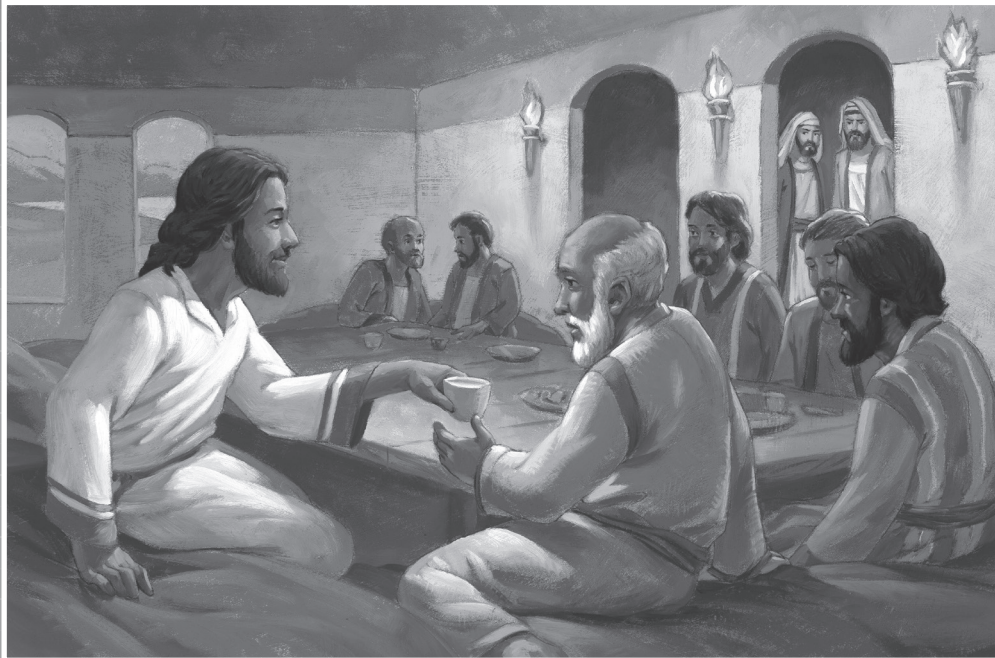

BIBLE STORY

Jesus Chose Matthew
(Matthew 9:9-13)

THE POINT

Jesus chooses to love me.
I can't earn it.

BONUS VERSE

- As the Father has loved me, I have also loved you. Remain in my love.
John 15:9
- As the Father hath loved me, so have I loved you: continue ye in my love.
John 15:9 (KJV)

Bible Story Summary

Jesus called Matthew, a tax collector, to follow Him. Matthew left everything behind and followed Jesus. Matthew hosted a banquet. Jesus and His disciples came to the banquet. The Pharisees complained and questioned why Jesus ate with tax collectors and sinners. Jesus told the Pharisees that He came not for the righteous but for sinners.

GATHER

- Everyday supplies
- 4-by-12-inch pieces of white foam board (1 per child)
- ¾-by-1-inch pieces of orange craft foam (16 per child)
- 16-inch strands of black cord (1 per child)
- VBS 2020 Theme Stickers* (005817939) or other theme related stickers
- Awl (leader use only)

ADVANCE PREPARATION

- Punch two holes in the top of each piece of the white foam with an awl.
- Cut the orange craft foam in the specified measurements with a slight slant on the long sides.
- Cut the strands of cord as per measurements given.
- Make a sample door hanger.



CRAFT CONNECTION

Welcome the kids to Bulldozer Crafts. Remind the kids that in today's Bible story Jesus called Matthew by name to follow Him. Say: "Jesus chose Matthew and loved him even though Matthew did nothing to earn His love. Jesus chooses to love us, too." Show the kids the door hanger you made and tell them they will make their own door hanger as a reminder that Jesus knows their name and loves them.

ASSEMBLE

Step 1: Glue eight of the orange foam pieces along the top edge of the white craft foam. Leave about a half an inch to an inch between each piece.

Step 2: Repeat Step 1 across the bottom of the white foam.

Step 3: Use a permanent marker to print your name in the center of the white foam between the orange rows.

Step 4: Thread one end of the cord through one of the holes and tie to secure. Repeat with the other end of the cord through the second hole to make the hanger.

Step 5: Use stickers to decorate the door hanger as desired.

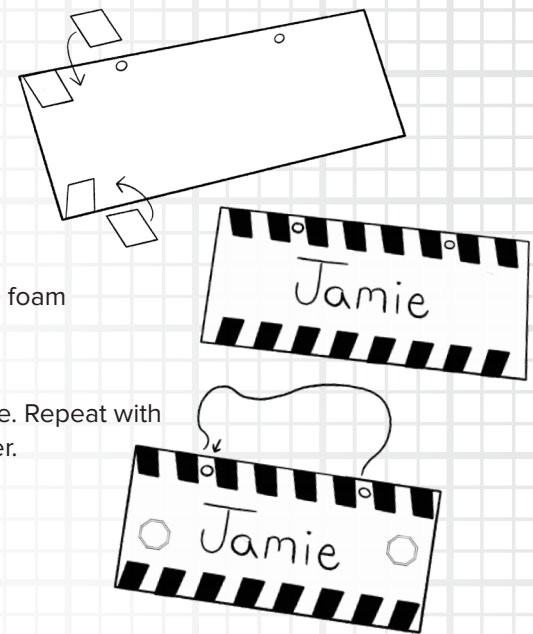

LEADER TIPS

- Tie the string on the hangers in advance for younger children.
- Use orange tape in place of the craft foam. Stick a length of tape to the table. Guide kids to draw diagonal lines on the tape and cut. Adhere the tape to the foam board.
- Materials for a similar craft can be found in the *VBS 2020 Barricade Door Hanger Craft Pack* (005821542).

KIDS SAID ...

I'll hang this on my door.
This is fun.



VOTED FAVORITE OF THE DAY

Jesus Loves Me Bag

GATHER

- Everyday supplies
- 8-inch-by-10 inch paper bags with handles (1 per child)
- Thin cardboard
- Painter's tape
- Chalk in a variety of colors
- Hair spray (leader use only)

ADVANCE PREPARATION

- Cut out heart templates from the thin cardboard to fit the center of the bag. You will need one per child per session.
- Make a sample Jesus Loves Me Bag.



CRAFT CONNECTION

Welcome the kids to Bulldozer Crafts. Show them a sample of the bag. Remind the children of today's point—Jesus chooses to love me! Tell kids that they will make their own bags to remind them of Jesus' love for them.

ASSEMBLE

Step 1: Write *Jesus Loves* across the top of the bag and your name in the center of the bag.

Step 2: Place a piece of tape in the center of the heart template. Tape the heart in place over your name.

Step 3: Color from the edge of the template outward about one to two inches all the way around the template with the chalk.

Step 4: Gently, use your finger to feather out and blend the lines of the chalk. Gently pull the template off the bag.

Step 5: Leader Step: Spray the chalk lightly with hair spray to keep it from rubbing off the bag.

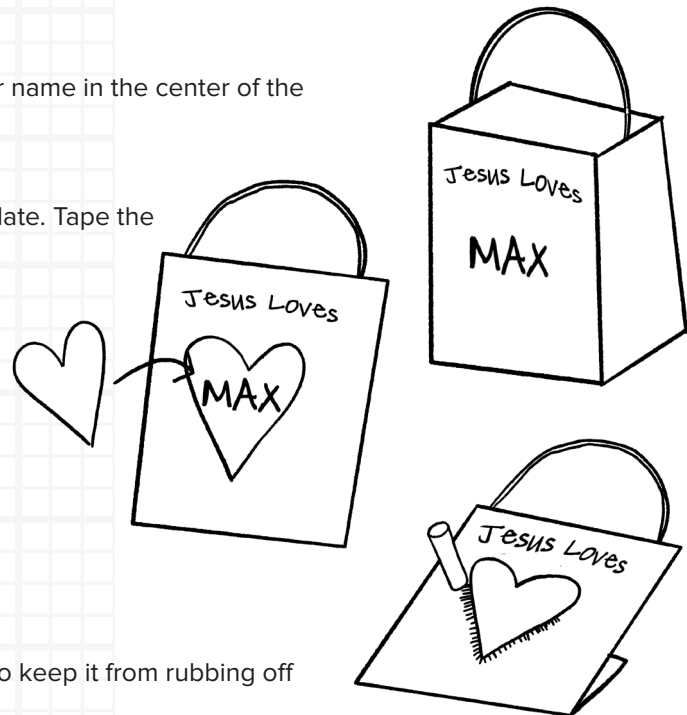

LEADER TIPS

- Use the bags for kids to place their crafts in for the week and send home on the last day of VBS. You may want to purchase larger bags if you will be using the bags for this purpose.
- Decorate with theme-related stickers, and write on the bags with metallic markers.

KIDS SAID ...

Pretty and obviously fun.
I like this idea!

Washer Bracelet

GATHER

- Everyday supplies
- 16-inch strands of cord in various colors (4 per child)
- 7/8-inch flat, metal washers (1 per child)
- Pony beads (1 per child)
- Extra-fine-tip permanent markers
- VBS 2020 Kids Memory Marker*, optional

ADVANCE PREPARATION

- Cut the cording into 16-inch strands.
- Make a sample Bracelet.



DAY 1

CRAFT CONNECTION

Welcome the kids to Bulldozer Crafts. Ask them to recall the point for the day—Jesus chooses to love me. I can't earn it. Show the kids the bracelet you made and tell them they will make a bracelet that will help them remember that Jesus loves them.

ASSEMBLE

Step 1: Choose two colors of cord. Fold them in half. Insert the loop into the washer, pull the ends over the washer and through the loop. Pull to tighten.

Step 2: Repeat Step 1 with the other two cords.

Step 3: Thread the four ends of one set of cord through a bead.

Step 4: Repeat Step 3 with the other set of cords going through the same bead in the opposite direction.

Step 5: Tie a knot in each set of cords. Trim the ends.

Step 6: Write the word *LOVE* on the washer with the fine-tip marker. If your kids are using the *VBS 2020 Memory Maker*, provide an extra washer for them to add to their Memory Maker Carabiners.

Steps 1 and 2

Step 3

Steps 4 and 5

LEADER TIPS

- Rub any mistakes with the marker off with alcohol and start again.
- Allow kids to make an extra bracelet to share with a friend if time allows.

KIDS SAID ...

Cool! This bracelet is knotty!

Day 2

Foundation of Forgiveness



BIBLE STORY

Paul's Redemption
(Acts 26:1-29)

THE POINT

Jesus loves me
regardless of my sin.

BONUS VERSE

- But God proves his own love for us in that while we were still sinners, Christ died for us. *Romans 5:8*
- But God commendeth his love toward us, in that, while we were yet sinners, Christ died for us. *Romans 5:8 (KJV)*

Bible Story Summary

Paul was chosen by God to bring the good news about Jesus to the Gentiles. He was arrested and later taken to King Agrippa to tell his story. Paul told how he used to persecute believers. But one day, on the road to Damascus, he saw a bright light and heard a voice speaking to him. The voice was Jesus. Paul obeyed Jesus' command and told people everywhere that Jesus is the Messiah.



Forgiven Backpack Tag

GATHER

- Everyday supplies
- Pony beads (2 per child)
- Cross beads (1 per child)
- Alphabet beads to spell *Forgiven* (1 set per child)
- 16-inch strands of cord (1 per child)
- Key rings (1 per child)
- Ziplock bags (1 per child)

ADVANCE PREPARATION

- Cut the strands of cord.
- Place a set of beads, a strand of cord, and a key ring in each ziplock bag.
- Make a sample backpack tag.



CRAFT CONNECTION

Welcome the kids to Bulldozer Crafts. Ask kids to recall how Paul lived before he had an encounter with Jesus. (*He persecuted believers and had them thrown in prison.*) Then ask kids how Paul's life changed after he believed in Jesus and was forgiven of his sins. (*He wanted to tell everyone about Jesus and how they could believe, too.*) Show the backpack tag and tell kids they will make their own tags as a reminder that Jesus loves and forgives us regardless of our sin.

ASSEMBLE

Step 1: Attach the cord to the key ring with a Hitch knot.

Step 2: Thread a pony bead on one strand of the cord from one side. Pull the other strand of cord through the other side of the bead.

Step 3: Add the letters in order to spell *Forgiven* by alternating both strands of the cord in opposite sides of the beads as you did in the previous step. Add the last pony bead after the letter *n*.

Step 4: Thread one side of the cord through the hole in the cross bead. Tie the two ends together to secure the bead to the tag. Cut off any excess cord. If your kids are using the *VBS 2020 Memory Maker*, provide an extra cross bead for them to add to their Memory Maker Carabiners.

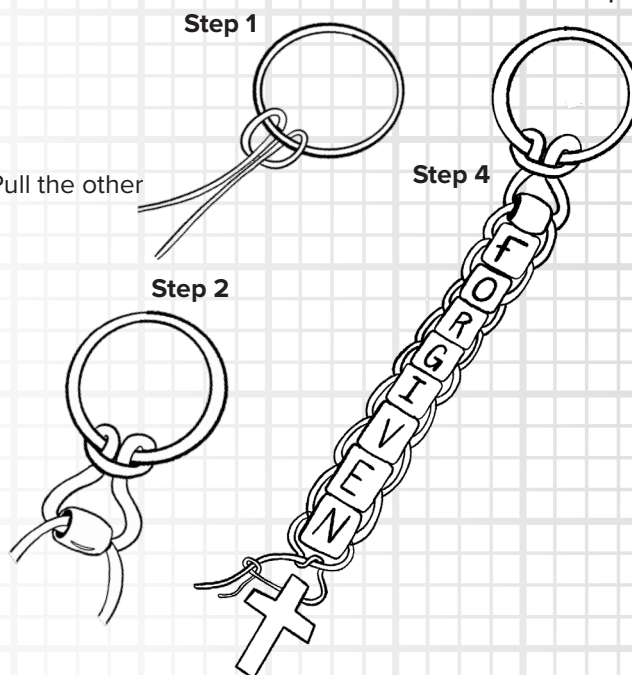

DAY 2

LEADER TIPS

- Use cord that has a waxy finish to help kids thread the beads or allow them to thread both pieces of cord through at once in one direction.
- Materials for a similar craft can be found in the *VBS 2020 Forgiven Backpack Tag Craft Pack* (005821543).

KIDS SAID ...

I'll put this
on my backpack!

I-beam Puzzle

GATHER

- ❑ Everyday supplies
- ❑ Large craft sticks (7 per child)
- ❑ Ziplock bags (1 per child)
- ❑ Self-adhesive magnets (7 per child)
- ❑ Painter's Tape
- ❑ White copy paper
- ❑ Bible Point Template, page 28

ADVANCE PREPARATION

- ❑ Tape a set of craft sticks together (side-by-side) with painter's tape for each child.
- ❑ Print and cut out a copy of the Bible Point Template for each child from the cardstock.
- ❑ Make a sample puzzle.

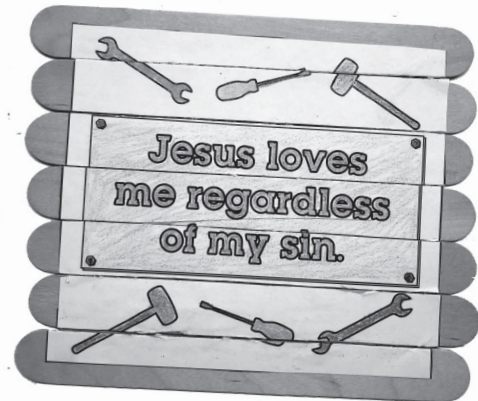

CRAFT CONNECTION

Welcome the kids to Bulldozer Crafts. Ask the kids to recall the story of Paul's redemption. Show them the puzzle you made and read the point out loud. Tell kids that today they will make their own puzzles that they can share with a friend to tell her about Jesus.

ASSEMBLE

Step 1: Color and decorate the Bible Point Template as desired.

Step 2: Glue the template to the side of the craft sticks that are not taped.

Step 3: Flip the craft sticks over so that the picture is turned toward the craft table and the back of the craft sticks are facing up.

Step 4: Place a magnet strip in the center of each craft stick.

Step 5: Remove the painter's tape. Fold one section at a time and cut along the fold.

Step 6: Place the craft sticks in the ziplock bag for storage.

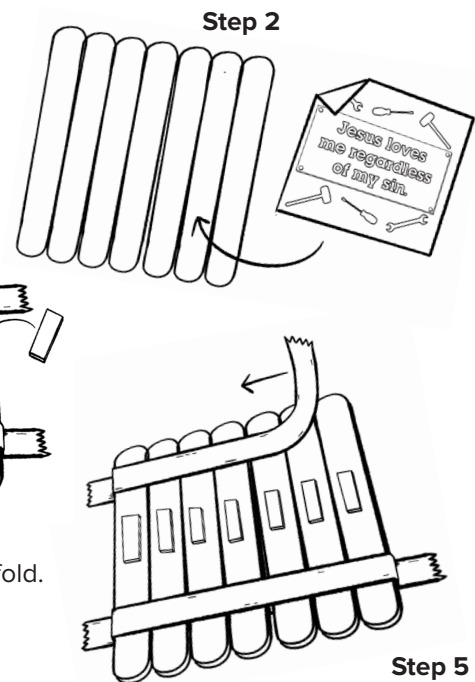

LEADER TIPS

- Allow kids to draw their own pictures, write today's Bible verse, or the VBS Scripture on their puzzles in place of using the template.
- Tell kids that they can put their puzzles together on a refrigerator or a cookie sheet.

KIDS SAID ...

This is cute.



**VOTED FAVORITE
OF THE DAY**

Glow-in-the-Dark Slime

GATHER

- Everyday supplies
- Small, round plastic containers with lids (1 per child)
- Glow-in-the-dark glue (5 ounces for every 4 children)
- Water (5 ounces for every 4 children)
- Contact solution (1 Tbsp. for every 4 children)
- Baking soda (½ Tbsp. for every 4 children)
- Measuring spoons (1 and ½ Tbsp. for every 4 children)
- Plastic mixing bowls (1 for every 4 children)
- Plastic mixing spoons (1 for every 4 children)

ADVANCE PREPARATION

- Set up stations for groups of four children.
- Make a sample batch of slime.



CRAFT CONNECTION

Welcome the kids to Bulldozer Crafts. Ask the children to recall Paul's experience on the road. Remind them of the bright light that shone from heaven when Paul was traveling. Say: "Today we will make slime that will glow in the dark to remind us of the light that Jesus brings to our lives when we trust Him and choose to obey Him."

DAY 2

ASSEMBLE

Step 1: Place kids in groups of four at each station.

Step 2: Pour the glue and water into the bowl and mix.

Step 3: Add the baking soda and mix thoroughly.

Step 4: Add the contact solution. Mix until mixture gets harder to mix and slime begins to form.

Step 5: Divide the mixture into four equal portions (one per child) and begin kneading. If it's too sticky, add more water.

Step 6: Place the slime in the container for storage.

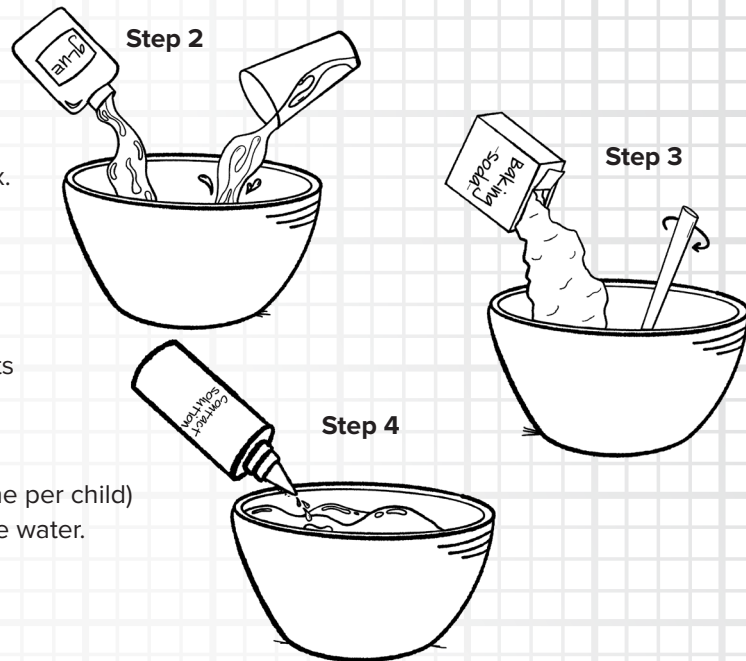

LEADER TIPS

- Send home an allergy alert the day before to assure that you do not have children with allergies to any of the supplies needed.
- Print the Point or the Bonus Verse for the day on the container lids or decorate them to resemble manhole covers.

KIDS SAID ...

**I love it!
It was so fun!**

Day 3

Foundation of Worth



BIBLE STORY

Jesus Prayed in the Garden
(Matthew 26:36-46)

THE POINT

Jesus chose to die for me

BONUS VERSE

- No one has greater love than this: to lay down his life for his friends.
John 15:13
- Greater love hath no man than this, that a man lay down his life for his friends. *John 15:13 (KJV)*

Bible Story Summary

On the last night Jesus spent with His disciples, He went to the Garden of Gethsemane to pray. He asked His disciples to remain awake and pray while He went further into the garden. Jesus was distressed because He knew He was going to die on the cross to save people from their sins. Jesus returned to the disciples three times and found them asleep each time. The last time He told the disciples to get up and follow Him. Jesus knew the time had come to follow through with God's plan.

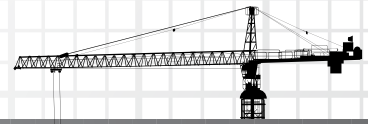

**VOTED FAVORITE
OF THE DAY**



Etched in Steel Cross

GATHER

- Everyday supplies
- Black craft foam
- Foil tape or aluminum foil
- Self-adhesive jewels (11 per child)
- Self-adhesive magnet strips (1 per child)
- Dull pencils (1 per child)

ADVANCE PREPARATION

- Cut the foam into 5-by-7-inch crosses. You will need one per child.
- Cut the foil into strips to fit over each part of the cross. You will need one set of strips per child.
- Make a sample cross.



CRAFT CONNECTION

Welcome the kids to Bulldozer Crafts. Show the kids the cross you made. Ask them why the cross is such an important symbol to us. (*Because Jesus died on the cross to take away the punishment for our sin.*) Tell the kids that today they will make a cross to remind them that Jesus loved them enough to die on the cross to save us from their sins.

ASSEMBLE

Step 1: Cover the front of the cross with the foil tape. Caution the kids that the tape will curl when the backing is removed. Be careful not to crease the foil.

Step 2: Using the dull pencil, lightly draw designs on the foil. Be sure to press gently.

Step 3: Adhere the jewels to the cross.

Step 4: Remove the backing from the magnet and secure it to the back of the cross.

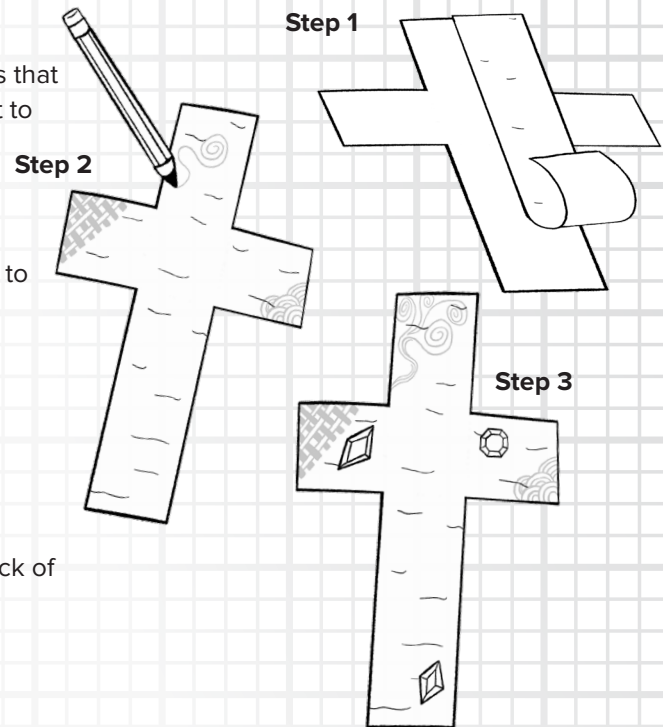

DAY 3

LEADER TIPS

- Purchase foil tape in the plumbing section at a hardware store.
- Apply the foil to the cross in advance for younger children.
- Materials for a similar craft can be found in the *VBS 2020 Etched In Steel Cross Craft Pack* (005821546).

KIDS SAID ...

Lord, help me make this cross! Aww! Super cool!

Prayer Tool Box

GATHER

- ❑ Everyday supplies
- ❑ Metallic poster board (1 sheet for every 6 children)
- ❑ Velcro® circles (1 set per child)
- ❑ Self-adhesive address labels (3 per child)
- ❑ Blank index cards (4–5 per child)
- ❑ Black cardstock
- ❑ *VBS 2020 Theme Stickers* (005817939) or other theme related stickers
- ❑ Tool Box Templates, page 29

ADVANCE PREPARATION

- ❑ Cut the poster board into 9-by-11-inch rectangles. Then cut a notch out of one of the short ends that is 1 inch deep and 2¾ inches in from each side. See illustration to the left.
- ❑ Fold the poster board paper into thirds so that the notch is at the top.
- ❑ Cut two 8½-by-3-inch rectangles from the black cardstock for each child.
- ❑ Trace and cut out the Tool Box Templates from black cardstock. You will need one set per child.
- ❑ Make a sample Prayer Tool Box.



Prep Step

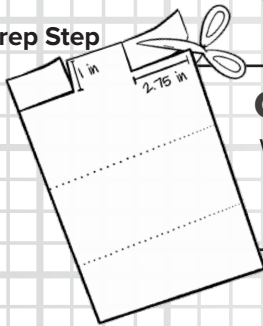

CRAFT CONNECTION

Welcome the kids to Bulldozer Crafts. Remind the children that in the Bible story today, Jesus prayed. Learning to pray is an important part of the Christian life. Tell the children that today they will make a Prayer Tool Box to keep prayers of praise and prayer requests in.

ASSEMBLE

- Step 1:** Apply glue to the two short sides and one long side of the one of the black rectangles. Adhere it along the bottom edge of the poster board on the nonmetallic side.
- Step 2:** Repeat Step 1 with the other black rectangle. Glue along the bottom edge of the middle fold to make a second pocket.
- Step 3:** Attach an address label to the center of each black pocket. Print *Things to thank God for* on one and *Things to ask God for* on the other.

Step 1

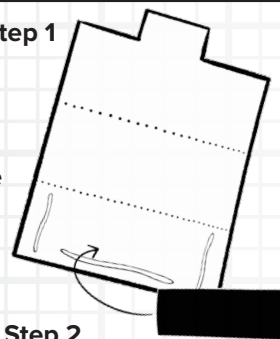

Step 2

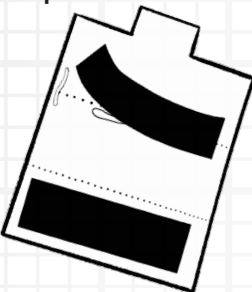

- Step 4:** Fold the tool box closed. Glue the handle to the top of the tool box and the corners to each side on the bottom of the box.

- Step 5:** Place one sticky side of the Velcro dot on the inside of the tab at the top. Stick the opposite side of the Velcro to it. Close the lid and the second Velcro dot will automatically stick to the correct spot on the tool box.

- Step 6:** Print prayers on the blank cards and decorate with stickers. Place each card in the appropriate pocket.

- Step 7:** Attach the last address label to the front. Print your name on the sticker.

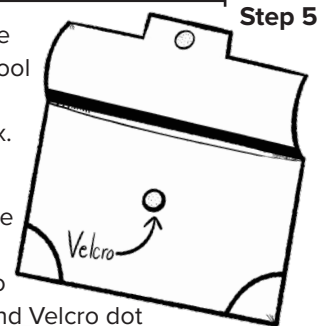

LEADER TIPS

- Use file folders folded into thirds in place of cutting out scrapbook paper.
- Use a “D” die cut to make the handle. The center can be cut in half to make the corner pieces.
- Provide tool-shaped die cuts for kids to print their prayers on and place in the pockets.

KIDS SAID ...

I have a lot more things to be thankful for. This is interesting.

Construct It Yarn Art

GATHER

- ❑ Everyday supplies
- ❑ 9-inch paper plates (1 per child)
- ❑ Yarn (2 yards per child)
- ❑ Plastic sewing needles (1 per child)
- ❑ Awl (leader use only)
- ❑ Hole punch
- ❑ Woven Heart Template, page 28

ADVANCE PREPARATION

- ❑ Print the Woven Heart Template.
- ❑ Tape the template to the back of the plate and punch holes where indicated.
- ❑ Make a sample of the yarn art hanging.



CRAFT CONNECTION

Welcome the kids to Bulldozer Crafts. Ask the kids how Jesus showed His love for us. (*He chose to die on the cross for our sins.*) Show the kids the wall hanging you made. Say: "Today you will make your own wall hanging to remind you that Jesus loves you, too."

ASSEMBLE

Step 1: Thread the yarn onto a needle and tape the loose end to the back of the plate.

Step 2: Bring the needle up through one of the holes and down through a hole in the opposite side. Continue until all the holes are sewn.

Step 3: Remove the needle, cut off all but a couple of inches of the extra yarn. Tape the end of the yarn to the back of the plate.

Step 4: Write *No one has greater love* on the plate around the heart.

Step 5: Punch a hole in the top of the plate. Tie a loop of yarn through the hole to make a hanger.

Step 1

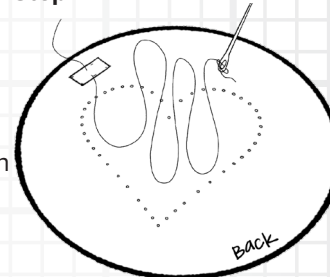

Step 2

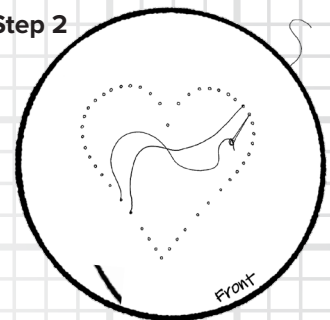

Steps 4 and 5

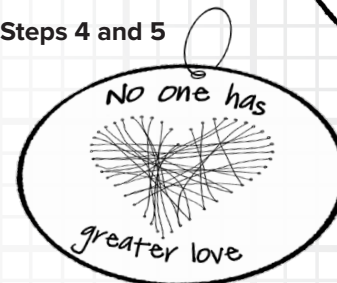

DAY 3

LEADER TIPS

- Pre-thread the needle and show the kids how to make sure they are using only one strand of yarn.
- Wind tape around the end of the yarn in place of using needles.

KIDS SAID ...

This is so pretty!

Day 4

Foundation of Promise



BIBLE STORY

Jesus' Resurrection and Promise (Matthew 28:1-10,16-20)

THE POINT

Jesus will always love me.

BONUS VERSE

- And remember, I am with you always, to the end of the age.
Matthew 28:20b
- Lo, I am with you always, even unto the end of the world.
Matthew 28:20b (KJV)

Bible Story Summary

On the Sunday after Jesus' death, Mary Magdalene and Mary the mother of James went to the tomb. When they arrived, they saw that the stone had been rolled away and an angel was sitting on it. The angel told the women that Jesus had risen. He instructed them to go tell the disciples to meet Jesus in Galilee. Later the disciples traveled to Galilee, where they saw Jesus. The disciples received instructions from Jesus and the promise that He would be with them always!

GATHER

- Everyday supplies
- 4-by-6-inch pieces of brown craft foam (1 per child)
- 2½-by-3½-inch self-stick mirror paper (1 per child)
- Self-adhesive magnet strips (1 per child)
- VBS 2020 Theme Stickers* (005817939) or other theme related stickers

ADVANCE PREPARATION

- Cut the foam and mirror paper to specified measurements.
- Make a sample mirror.



CRAFT CONNECTION

Welcome the kids to Bulldozer Crafts. Ask the kids to recall what Jesus' promise was in today's story. (*To always be with us.*) Remind kids that Jesus' promises are always true, and He keeps every promise He makes. Tell the kids they are going to make a mirror to remind them of Jesus' promise to always love them.

ASSEMBLE

Step 1: Peel the backing from the mirror paper and center it in the middle of the foam.

Step 2: Print *Jesus will always love ...* above the mirror. Use a marker to draw lines to simulate wood grain around the mirror.

Step 3: Decorate around the mirror with stickers.

Step 4: Peel the backing from the magnet and adhere it to the back of the craft foam.

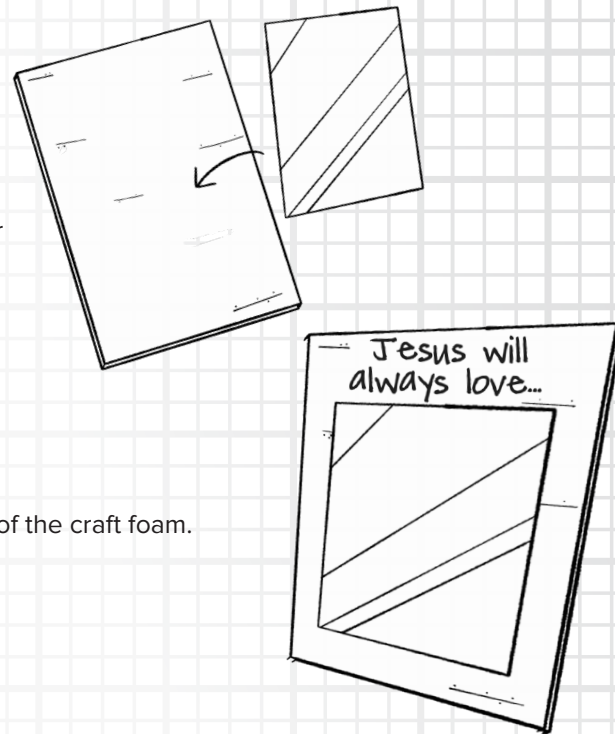

LEADER TIPS

- Be sure to pull the plastic film from the front of the mirror paper if one is applied.
- Materials for a similar craft can be found in the *VBS 2020 Jesus Loves ... Mirror Craft Pack* (005821547).

KIDS SAID ...

It works! I'll put this on my locker

GATHER

- Everyday supplies
- 8½-by-11-inch pieces of silver scrapbook paper (1 sheet per child)
- 8½-by-11-inch pieces of thin cardboard (1 sheet per child)
- Dull pencils (1 per child)
- Velcro® circles (1 set per child)
- Rulers (1 per child)
- VBS 2020 Theme Stickers* (005817939) or other theme related stickers
- Pouch Templates, page 30

ADVANCE PREPARATION

- Copy and cut out one Pouch Template per child from the cardboard.
- Trace the lines to be scored on each piece of cardboard.
- Make a sample coin pouch.



CRAFT CONNECTION

Welcome the kids to Bulldozer Crafts. Ask the kids to recall the Point for today. (*Jesus will always love me.*) Remind kids that because we know Jesus loves us we should want to share that good news with others. Show them the coin pouch and tell them they will make a pouch to collect coins to give to missions or at church to help others learn how much Jesus loves them.

ASSEMBLE

Step 1: Use a glue stick to apply glue to the blank side of the cardboard. Glue the scrapbook paper to the cardboard with the decorative side facing up.

Step 2: Lay the ruler along each dotted line and use a dull pencil or closed pen to score each line.

Step 3: Fold the template on the scored lines. Use an accordion fold on the sides of the pouch.

Step 4: Place one sticky side of the Velcro dot on the inside of the flap on the pouch. Stick the opposite side of the Velcro to it. Close the flap and the second Velcro dot will automatically stick to the correct spot on the pouch.

Step 5: Print *Jesus will always love me* across the flap of the pouch. Decorate with stickers as desired.

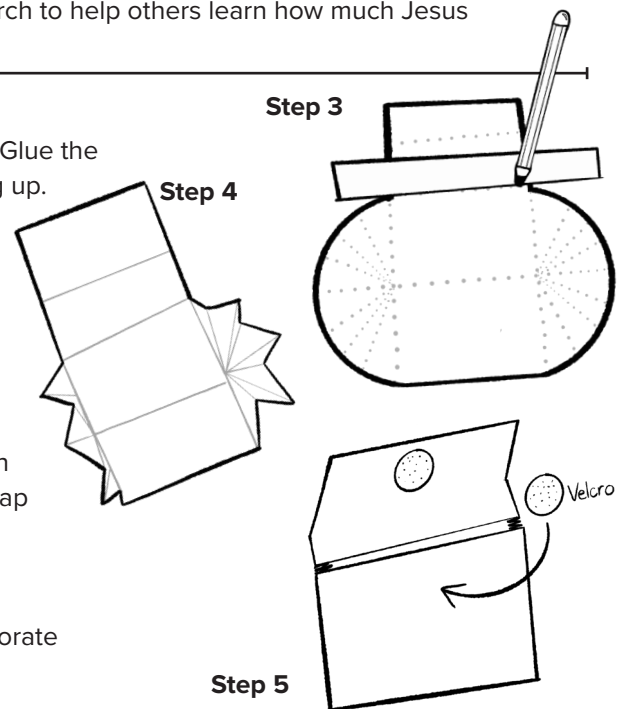

LEADER TIPS

- Use cardboard cereal or food boxes to add color and skip the scrapbook paper steps.
- Score the cardboard in advance for younger children.
- Materials for a similar craft can be found in the *VBS 2020 Galvanized Coin Pouch Craft Pack* (005821548).

KIDS SAID ...

This feels like origami!

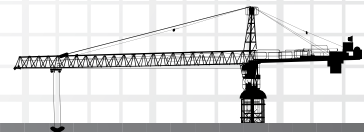

VOTED FAVORITE OF THE DAY

Blueprint Maze

GATHER

- Everyday supplies
- Neon cardstock (1 sheet for every 2 children)
- Circle magnets (1 per child)
- Paper clips (1 per child)
- 16-inch strands of ribbon (1 per child)
- Golf tees (1 per child)
- White cardstock (1 sheet for every 10 children)
- Laminator and film (leader use only)
- Hot glue gun and glue (leader use only)
- Construction Worker Template, page 32
- Maze Template, page 32

ADVANCE PREPARATION

- Copy a Maze Template for each child on the neon cardstock. Laminate each maze.
- Copy and cut out a Construction Worker Template for each child on the white cardstock.
- Cut the ribbon and glue one end to the center of a magnet with the hot glue.
- Attach a golf tee to each magnet with the hot glue. Be sure to sandwich the ribbon between the magnet and the tee.
- Make a sample maze

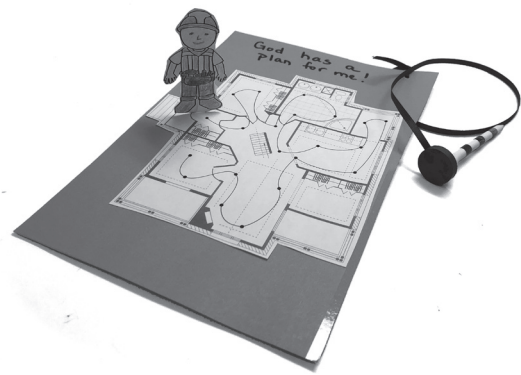

CRAFT CONNECTION

Welcome the kids to Bulldozer Crafts. Tell the children that before builders begin constructing houses, they have to have blueprints to know what they're supposed to do. God has a blueprint for our lives that always begins with having a personal relationship with Him. Today you will make a blueprint maze to help you remember that God has a plan for your life.

ASSEMBLE

Step 1: Color the construction worker.



Step 2: Open the paper clip and tape the construction worker to the clip so that it stands up.

Step 3: Punch a hole in one corner of the maze. Tie the loose end of yarn through the hole.

Step 4: Use the magnet to guide the construction worker through the blueprint from room to room.

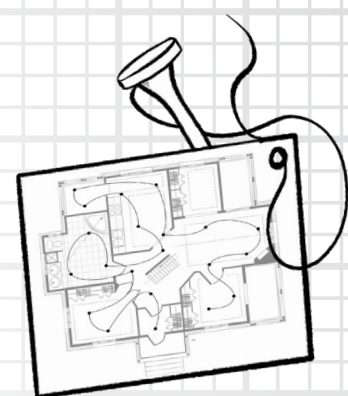

DAY 4

LEADER TIP

Print the words to Matthew 28:20b in the translation of your choice in random order on the blueprint. Challenge the kids to move the construction worker to the words in the correct order.

KIDS SAID ...

This is cute.
We could have races!

Day 5

Foundation for Life



BIBLE STORY

Wise and Foolish Builders
(Matthew 7:24-29)

THE POINT

Jesus' love is the foundation for
the rest of my life.

BONUS VERSE

- But as for you, continue in what you have learned and firmly believed. You know those who taught you. *2 Timothy 3:14*
- But continue thou in the things which thou hast learned and hast been assured of, knowing of whom thou hast learned them. *2 Timothy 3:14 (KJV)*

Bible Story Summary

Jesus told a parable about two builders. He said that everyone who heard His words and acted on them would be like the wise man who built his house on the rock. The house had a strong foundation and would stand against the wind and the rain. However, those who did not listen would be like the foolish builder who built his house on the sand. Once the wind and rains came, the house collapsed. If people listen and obey Jesus, they will have a strong foundation for whatever happens in their lives.

Wise Builder Photo Frame

GATHER

- Everyday supplies
- Brown, green, yellow, white, and gray craft foam.
- Self-adhesive magnet strips (1 per child)
- House Template, page 31
- Fence Template, page 31
- Rock Template, page 31
- Roof Template, page 31

ADVANCE PREPARATION

- Cut two 3-by-1/2-inch rectangles from the yellow craft foam per child.
- Trace and cut out one House Template from the brown foam per child.
- Trace and cut out one Rock Template from the gray foam per child.
- Trace and cut out one Roof Template from the green foam per child.
- Trace and cut out two of the Fence Templates from the white foam per child.
- Make a sample photo frame.



CRAFT CONNECTION

Welcome the kids to Bulldozer Crafts. Ask the children to recall who was the wise builder in the Bible story. (*The one who listened and obeyed God.*) Remind the kids that Jesus' love is the foundation for the rest of their lives and that they should choose to be like the wise builder who built on the solid foundation that Jesus provides.

ASSEMBLE

Step 1: Glue the yellow rectangles on each side of the windows as shutters.
Glue the roof to the house frame.

Step 2: Use a marker to draw lines on the fence pieces and glue them to the frame.

Step 3: Glue the rock piece to the bottom edge of the house on the back side.

Step 4: Print *Jesus is my foundation* across the rocks on the front side of the frame.

Step 5: Attach the magnet to the back side of the frame and tape a picture in the opening.

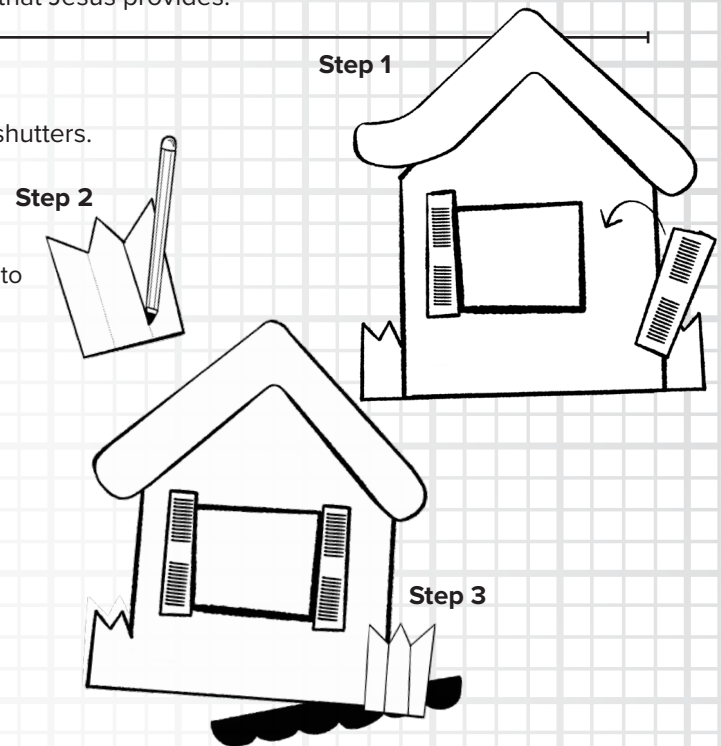

LEADER TIPS

- Plan to take photos of the kids early in the week to have them ready for the craft.
- Materials for a similar craft can be found in the *VBS 2020 Wise Builder Photo Frame Craft Pack* (005821550).

KIDS SAID ...

The wise man built his house upon the rock.

Solid Rock Trivet

GATHER

- ❑ Everyday supplies
- ❑ 4-inch squares of MDF or wood (1 per child)
- ❑ Small felt squares (4 per child)
- ❑ River pebbles
- ❑ Aleene's Clear Gel Tacky Glue®

ADVANCE PREPARATION

- ❑ Cut the MDF or wood into squares.
- ❑ Cut the felt into small squares.
- ❑ Make a sample trivet.



CRAFT CONNECTION

Welcome the kids to Bulldozer Crafts. Remind the children that the wise man in the Bible Story today built his house on the rock. Tell kids they will make a rock trivet to remind them to be like the wise man.

ASSEMBLE

Step 1: Glue the felt pieces in the corners on the bottom of the square. Turn the square over to the opposite side.

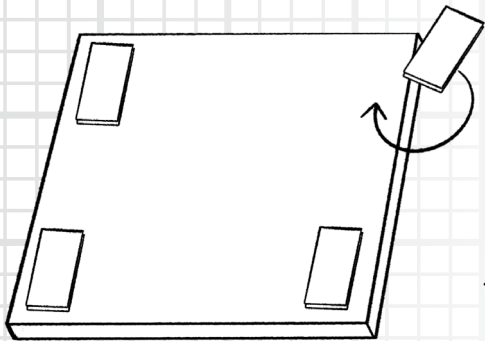

Step 2: Start in the center of the square and lay your pebbles outward in a spiral toward the edges. Try to be sure the pebbles are close to the same thickness to make a smoother surface

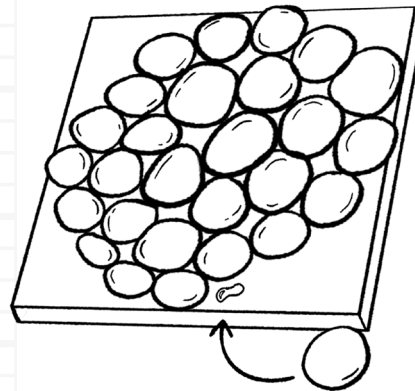

Step 3: Pick up three to four pebbles and apply glue to the square. Lay the pebbles back down on top of the glue.

Step 4: Repeat Step 3 until all the pebbles have been glued down.

LEADER TIPS

- Use cardboard coasters from dollar stores in place of the wood.
- Remind kids to glue the flat side of the pebble to the wood.

KIDS SAID ...

I'll give it to my mom.

Concrete & Cranes™ Tape Measure

GATHER

- ❑ Everyday supplies
- ❑ Rectangular boxes such as a macaroni and cheese box (1 per child)
- ❑ 1-by-12-inch strips of yellow paper (1 per child)
- ❑ 1-inch strips of foil tape (1 per child)
- ❑ Blank sticker paper
- ❑ Black paper
- ❑ Sticker Template, page 32

ADVANCE PREPARATION

- ❑ Cut the boxes in half. Then cut one half of each box diagonally from the top corner to the bottom corner. (See Step 2 for an illustration.)
- ❑ Cut the yellow paper and foil tape into specified measurements.
- ❑ Print one Sticker Template for each child on the sticker paper.
- ❑ Make a sample tape measure.



CRAFT CONNECTION

Welcome the kids to Bulldozer Crafts. Read 2 Timothy 3:14 in the translation of your choice. Point out that the verse instructs us to continue or keep doing the things we have learned from the Bible and Jesus. Tell the kids they will make a fun tape measure to help remind them to continue doing the things they learned about at VBS and to continue learning about Jesus everyday.

ASSEMBLE

Step 1: Fold the foil tape over one end of the yellow strip.

Print numbers and lines on the strip to simulate a tape measure. Above the numbers print *Continue in what you have learned*.

Step 2: Tape the end without the foil tape inside the edge of the square box.

Step 3: Slide the diagonal box into the square box. Push the yellow strip inside the box leaving the foil tape end sticking out.

Step 4: Cover the box with the black paper leaving a space for the tape opening.

Step 5: Color the sticker and place it in the center of the box.

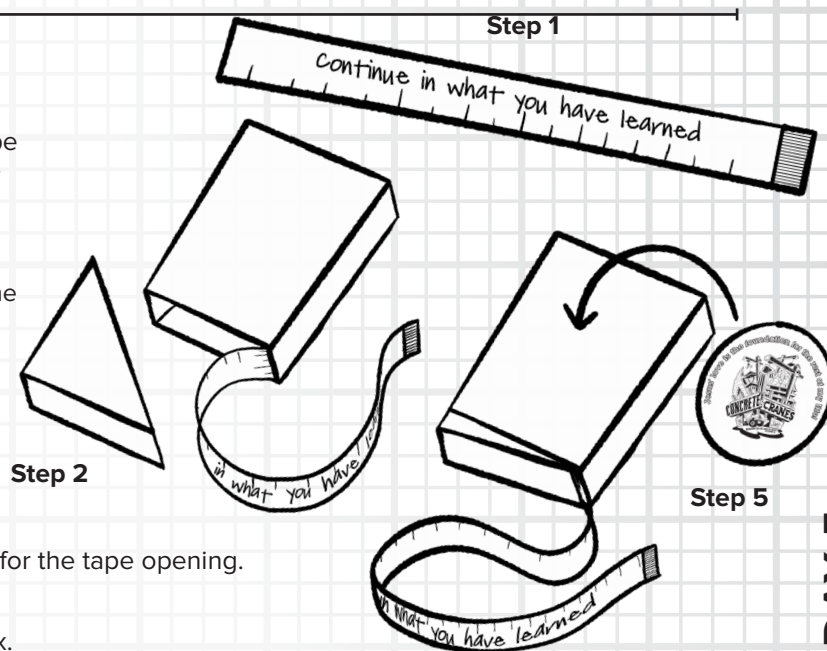

LEADER TIPS

- Use a 3-inch hole punch to cut out the stickers.
- Attach the yellow strip in advance for younger children.
- Purchase small gift boxes at a dollar store or use gelatin boxes instead of the macaroni and cheese boxes.
- Cover the boxes with black duct tape in place of the black paper.

KIDS SAID ...

This is cute! I'll use it to trick my mom.

Preteen crafts

Day 1 Nailed It String Art

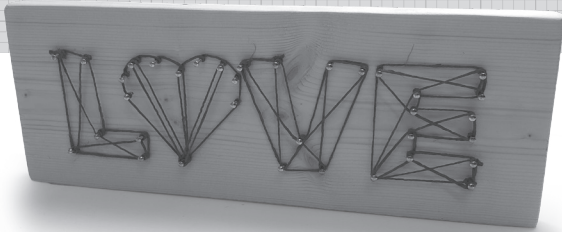

Day 2 Carpenter's Pencil Magnet

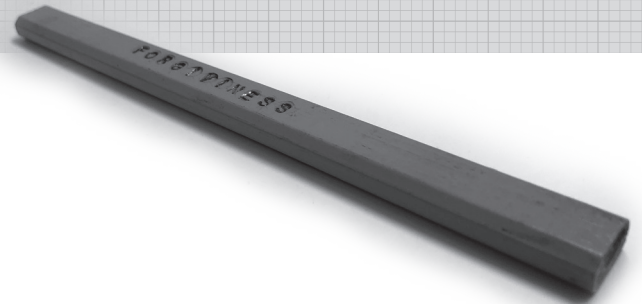

Day 3 Sandpaper Art T-shirt



Day 4 Jesus Will Never Lego™ Frame

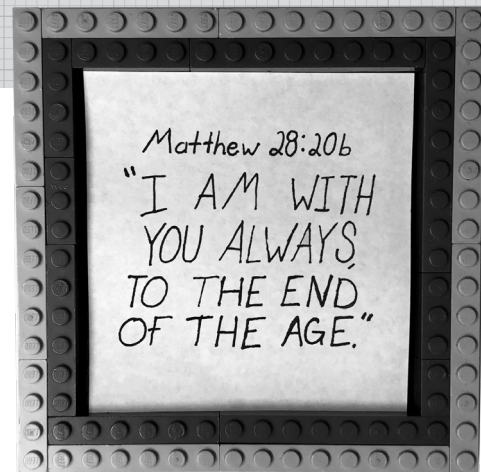

Day 5 Nuts & Bolts Fidget Spinner



Note: Full step-by-step instructions from each of these crafts can be found in *VBS 2020 VBX® Preteen Bible Study Leader Guide* (005816501) on pages 13, 20, 27, 34, and 41.



Concrete Planter (3–5 Day Craft)

GATHER

- ❑ Everyday supplies
- ❑ Stepping stone or cement mix (1½ cups per child)
- ❑ Water (¼ to ⅓ cup per child)
- ❑ 16-ounce plastic cups (1 per child)
- ❑ Plastic spoons (1 per child)
- ❑ Clean plastic containers (1 per child)
- ❑ 8-ounce waxed cups (2 per child)
- ❑ Ziplock bags (1 per child)
- ❑ Small rocks (3-4 per child)
- ❑ Paint or paint pens in various colors
- ❑ Paint brushes (several for kids to share)
- ❑ Potting soil
- ❑ Small succulent or grass seed (1 per child)
- ❑ Plastic tablecloths

ADVANCED PREPARATION

- ❑ Cover the tables with tablecloths.
- ❑ Wash and clean out the plastic containers you collected. Any type of plastic food tub, bottom portion of 2-liter bottles, or bottom portion of sports drink bottles will work well.
- ❑ Make a sample planter.

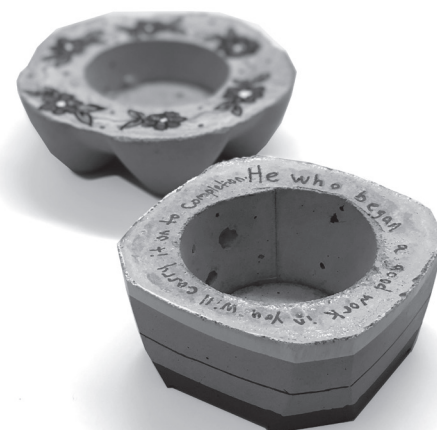

DAY 1

ADVANCED PREPARATION

Place the stepping stone or cement mix into a ziplock bag for each child.

ASSEMBLE

- Step 1:** Empty the cement mix carefully into a 16-ounce cup.
- Step 2:** Pour the water into the cup with the mix.
- Step 3:** Mix well with the plastic spoon. Be sure to scrape along the bottom of the cup so the mix is well incorporated with the water.
- Step 4:** Write your name on the bottom of the plastic container. Pour the mixture into the container.
- Step 5:** Press the smaller cup into the center of the cement mixture. Place a few rocks in the cup to weigh it down.
- Step 6:** Set aside and let dry for 24 hours.

LEADER TIPS

- Give students small stones or clear marbles to press around the small cup in the top of the container.
- Coat your containers with cooking oil if you are worried about the cement sticking.

DAY 2

ADVANCED PREPARATION

Set the paint and brushes out on the tables.

ASSEMBLE

- Step 1:** Take the rocks out of the cup. Twist the cup to remove it from the cement.
- Step 2:** Remove the plastic container from the bottom of the cement. You may need to snip a small section with scissors to get started.
- Step 3:** Write your name on the bottom of the cement pot with a permanent marker.
- Step 4:** Use the paint to paint designs around the outside of the cement container.
- Step 5:** Set the container aside to dry.

LEADER TIP

Provide small stencils or design ideas for children to paint onto their planters.

DAY 3

ADVANCED PREPARATION

Place a small amount of potting soil for each child in an 8-ounce cup.

ASSEMBLE

- Step 1:** Place some potting soil in the center of the planter.
- Step 2:** Plant the succulent or grass seed in the soil. Add more soil around the plant if needed.
- Step 3:** Add a little water to the plant.

LEADER TIP

Kids can make this into a candle holder with a small votive or tea light candle or they can make it a trinket holder to place on a dresser to hold jewelry or change.

Woven Heart Template, Day 3

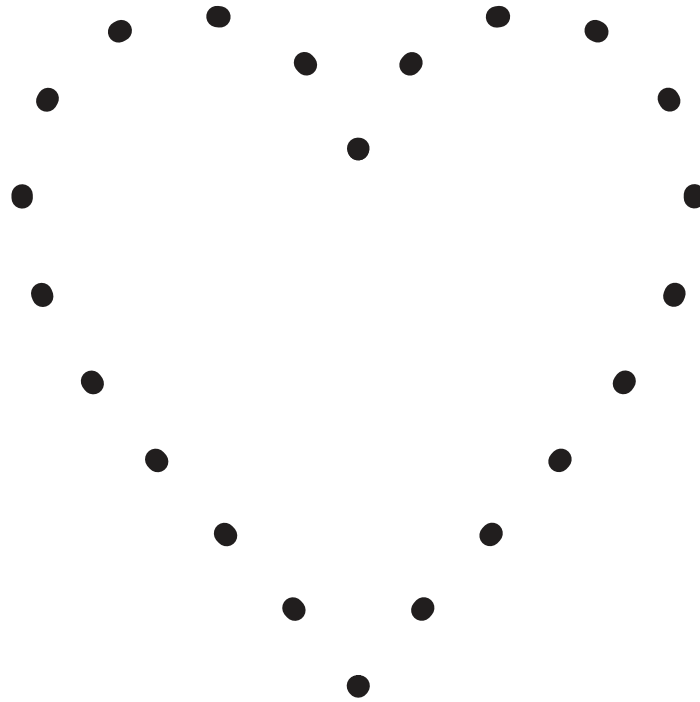

Bible Point Template, Day 2

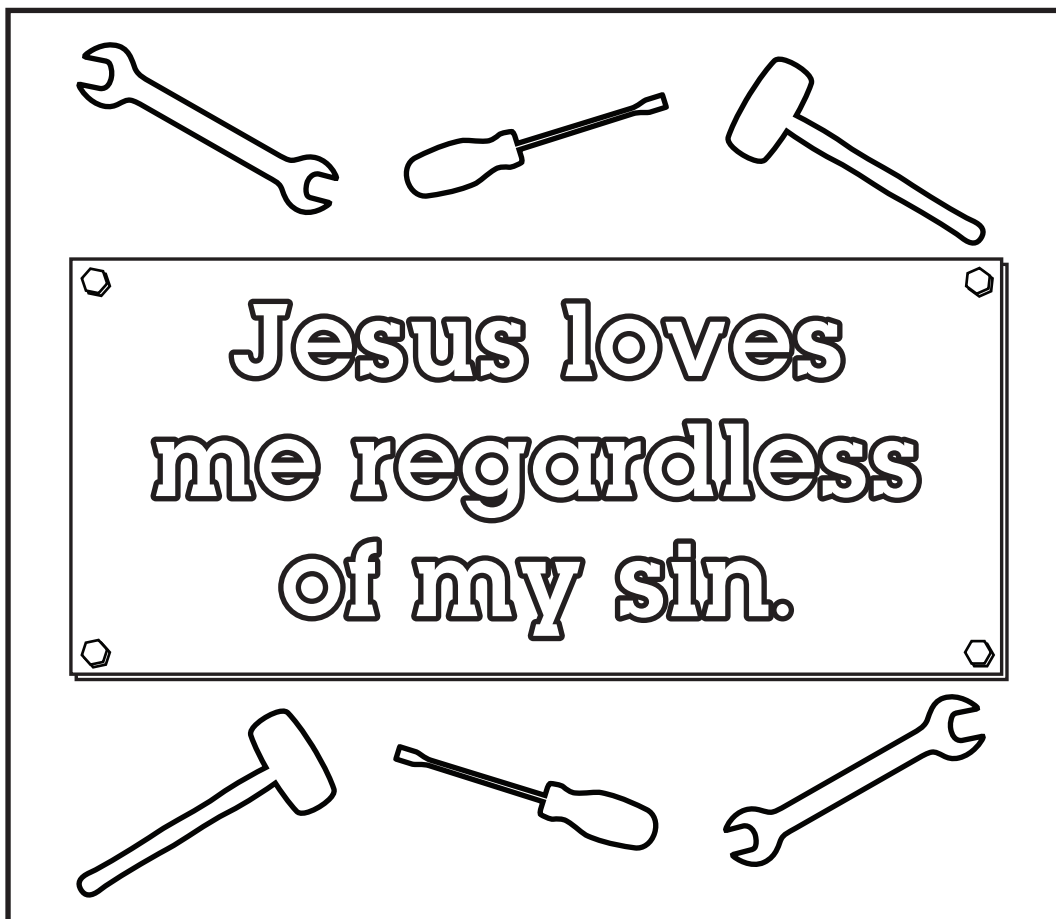

Tool Box Templates, Day 3

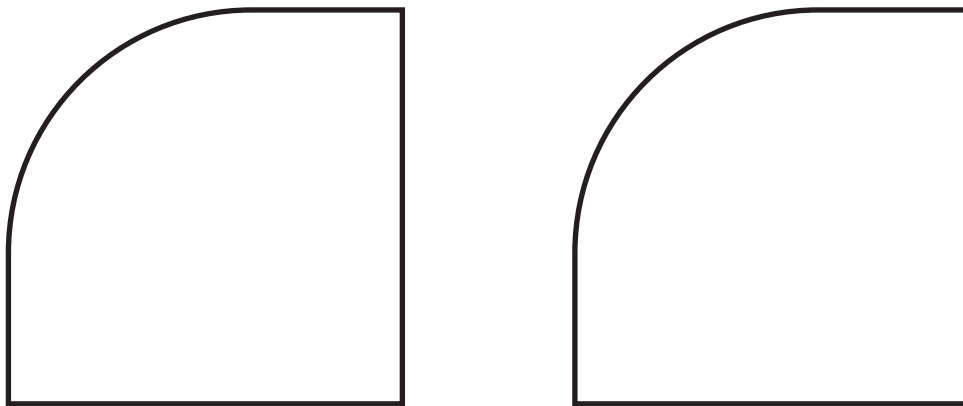
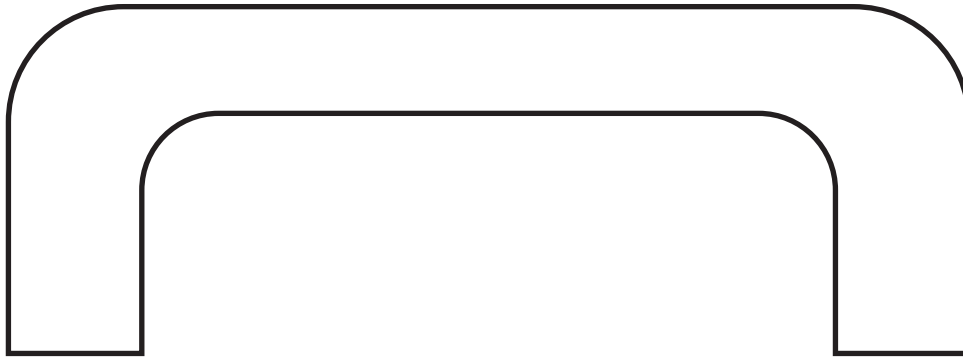

Pouch Template, Day 4
Zoom 125%

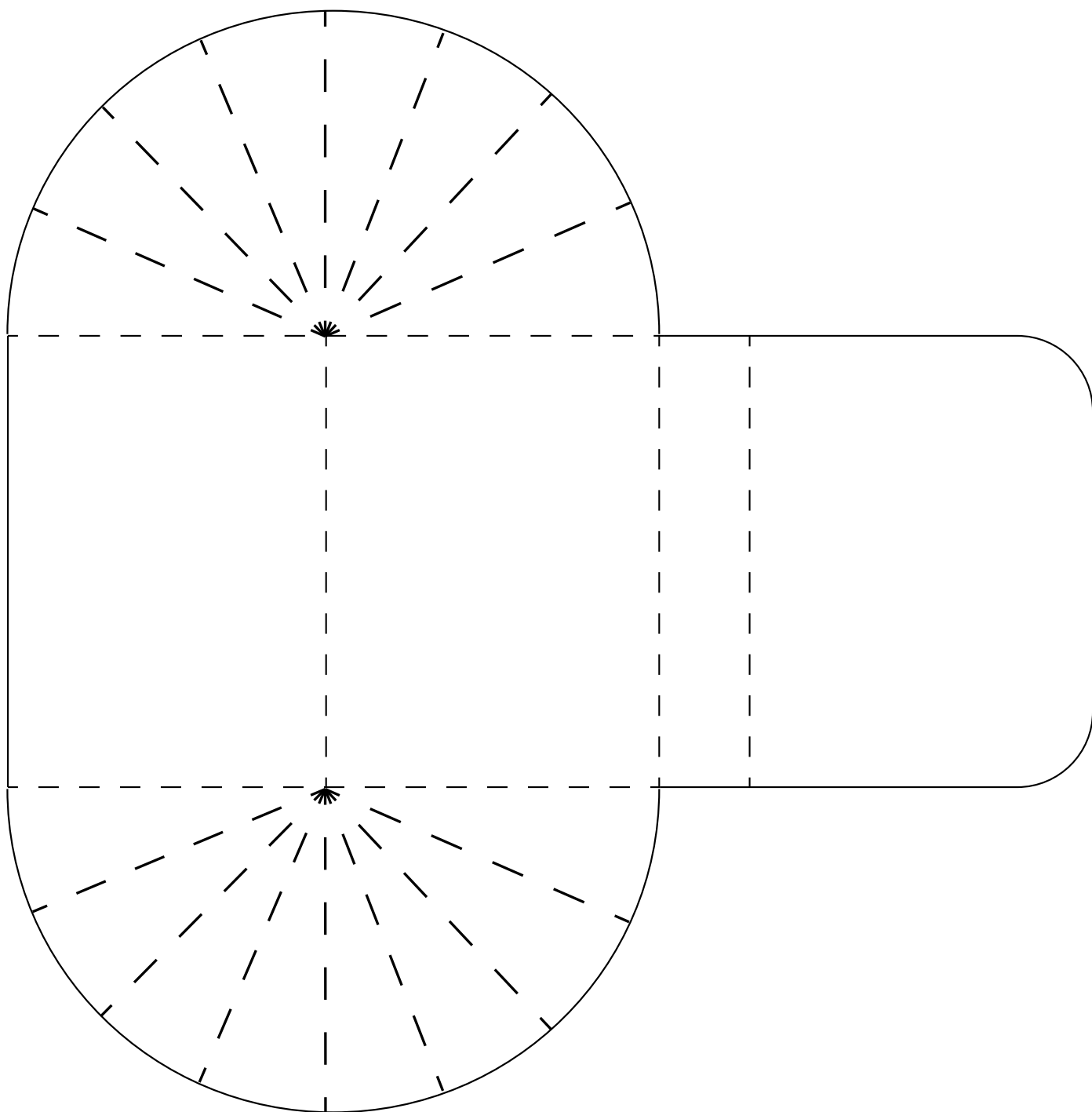

Fence Template, Day 5
Zoom 150%

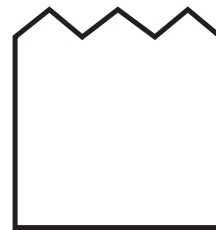
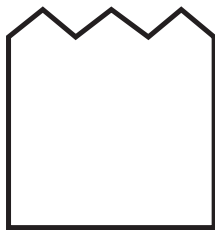

Roof Template, Day 5

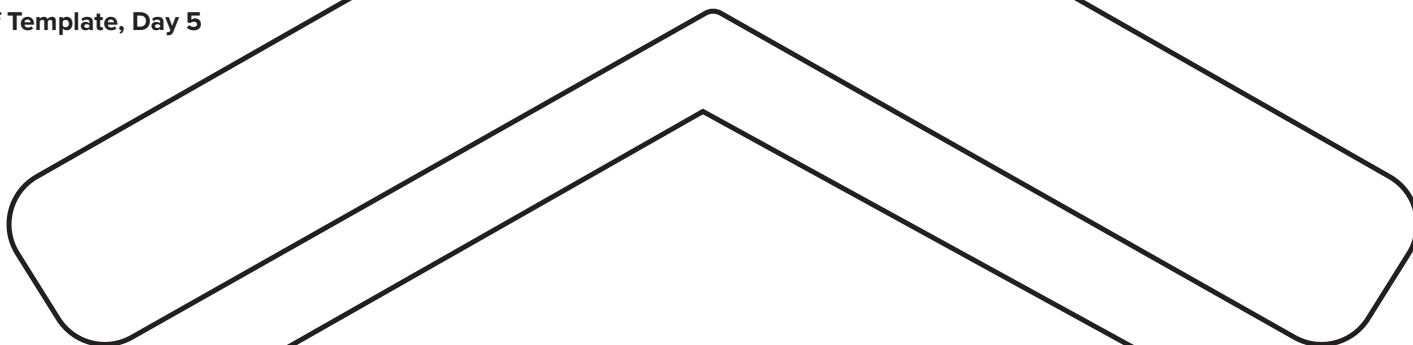

House Template, Day 5

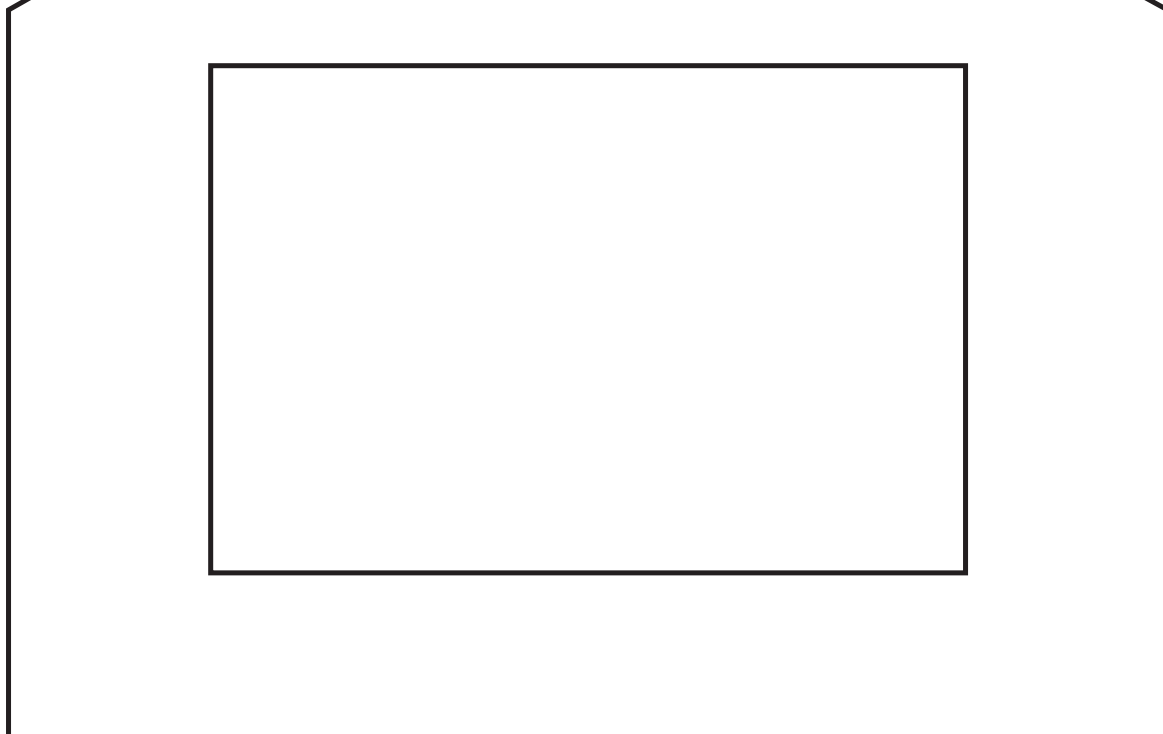

Shutters Template, Day 5



Rock Template, Day 5

Construction Worker Template, Day 4



Sticker Template, Day 5

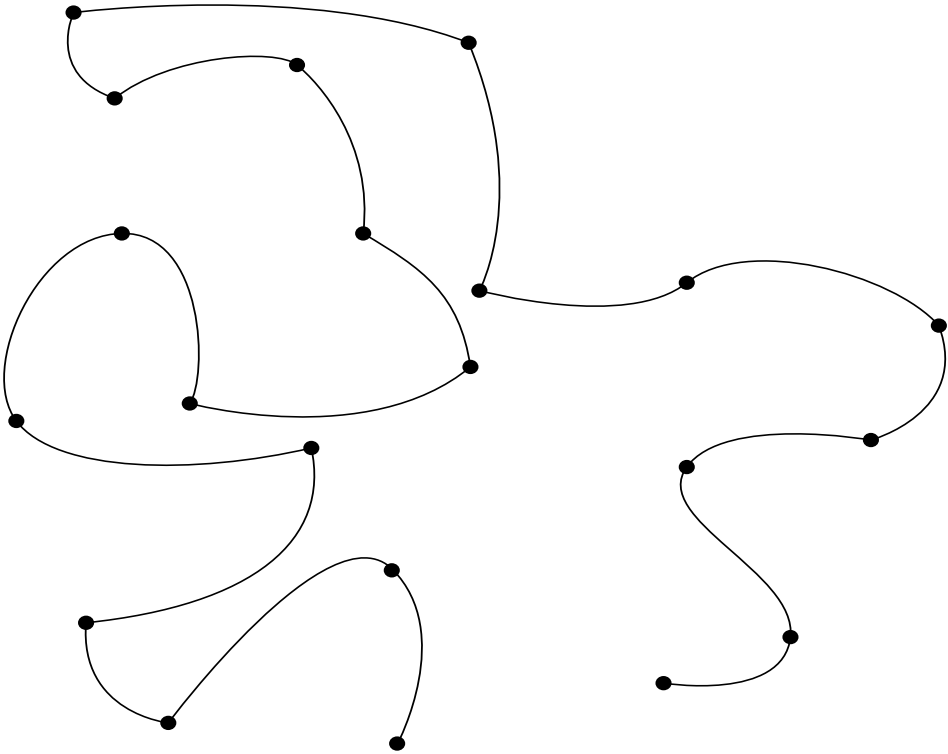
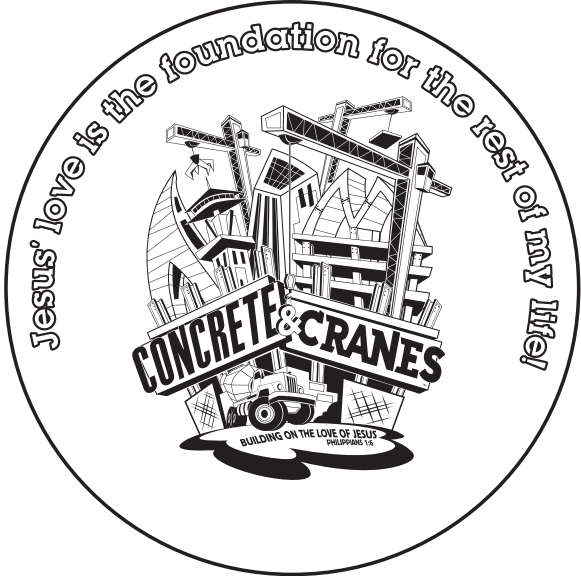

Maze Template, Day 4